

Turbotron // VTH15, VTM15, VTP15, VTI15

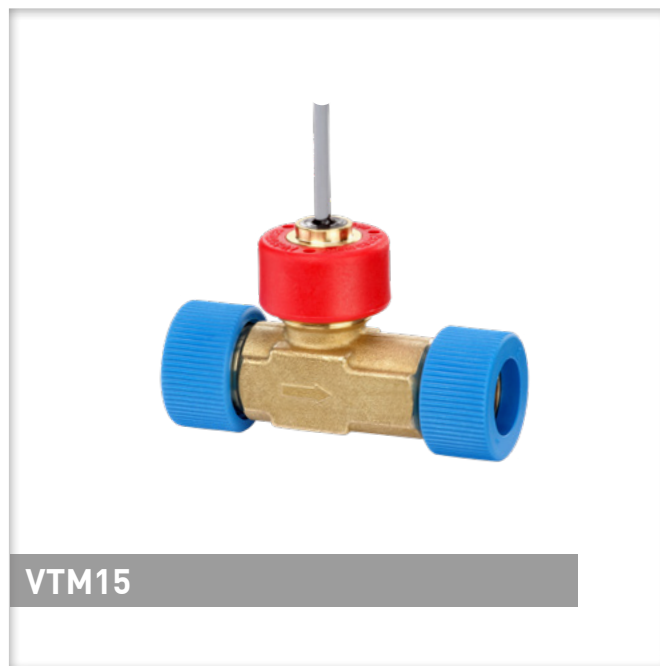

VTH15

**BEST
SELLER**



VTM15

Your advantages

Series	VTH15	VTM15
	<ul style="list-style-type: none"> • Cost optimized version 	<ul style="list-style-type: none"> • For medium temperature up to 120 °C

Type	VTH15			VTM15
Material pipe section	Plastic PPO	Brass	Stainless steel	Brass
Flow range	2...40 l/min			2...20 l/min
Accuracy	±0.4 l/min			
Repeatability	±0.1 l/min			
Signal output	From 0.3 l/min			
Medium temperature	0...85 °C (non-freezing)			0...120 °C (non-freezing)
Pressure rating	PN 10			
Nominal diameter	DN 15			
Process connection	G $\frac{3}{4}$ male thread with union nuts and gaskets			
Sensor	Hall effect sensor			
Output signal				
→ Pulse rate / K-factor	855 pulses/l			915 pulses/l
→ Resolution	1.2 ml/pulse			1.1 ml/pulse
→ Signal shape	Square wave signal NPN open collector			Square wave signal NPN open collector
→ Signal current	Max. 10 mA			Max. 10 mA
Electrical connection	1.5 m PVC cable, shielded (T _{max} = 70 °C) or 4 pin plug connector M12 x 1			1.5 m PVC cable, shielded (T _{max} = 80 °C)
Power supply	4.5...24 VDC			
Degree of protection EN 60529	IP54			
Max. particle size in the medium	0.5 mm			



VTP15





VTI15

Your advantages

Series	VTP15	VTI15
	<ul style="list-style-type: none"> • Pressure rating up to 300 bar • For medium temperature up to 150 °C 	<ul style="list-style-type: none"> • Magnet-free rotor, for high measurement accuracy and high resolution

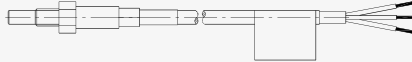
Type	VTP15		VTI15	
Material pipe section	Brass	Stainless steel	Plastic PPO	Brass
Flow range	2...40 l/min			
Accuracy	±0.4 l/min of range at 2...20 l/min		±0.2 l/min	
Repeatability	±0.1 l/min		±0.05 l/min	
Signal output	From 0.3 l/min			
Medium temperature	0...150 °C (non-freezing)		0...85 °C (non-freezing)	
Pressure rating	P _{max} = 300 bar		PN 10	
Nominal diameter	DN 15			
Process connection	G $\frac{3}{4}$ male thread incl. union nuts	G $\frac{3}{4}$ male thread or G $\frac{3}{4}$ female thread	G $\frac{3}{4}$ male thread with union nuts and gaskets	
Sensor	Hall effect sensor		Inductive proximity switch	
Output signal	915 pulses/l 1.1 ml/pulse Square wave signal NPN open collector Max. 10 mA		1795 pulses/l 0.6 ml/pulse Square wave signal PNP or NPN open collector Max. 50 mA	
Electrical connection	1.5 m silicone cable, shielded (T _{max} = 150 °C)		2 m PVC cable, shielded (T _{max} = 70 °C) or 4 pin plug connector M12 x 1	
Power supply	4.5...24 VDC		10...30 VDC	
Degree of protection EN 60529	IP54			
Max. particle size in the medium	0.5 mm			

Options		VTH	VTM	VTP	VTI
See order code					
Integrated temperature sensor with plug connection M8 → Pt100, class B, 3-wire → Pt1000, class B, 3-wire Immersion tube → Brass → Stainless steel		✓			✓
Integrated temperature sensor with fixed cable (T_{max} = 80 °C) → Pt100, class B, 3-wire → Pt1000, class B, 2-wire Immersion tube → Brass → Stainless steel		✓	✓		✓
Screen filter in the inlet, hat shape mesh size 0.5 mm T_{max} = 60 °C (continuous operation) T_{max} = 85 °C (max. 1 h)		✓			✓
Turbine flow transmitter, analogue output 4...20 mA (T_{max} = 80 °C)	see options Turbotron	✓			
Turbine flow switch, switching output (contact) (T_{max} = 80 °C)	see options Turbotron	✓			
On request					
Optional seal materials → FKM → EPDM		✓			✓
Integrated temperature sensor with fixed cable → NTC → PTC		✓			✓

Characteristic curve VTH

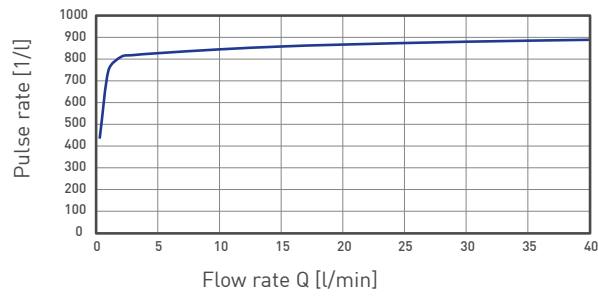

Characteristic curve VTI

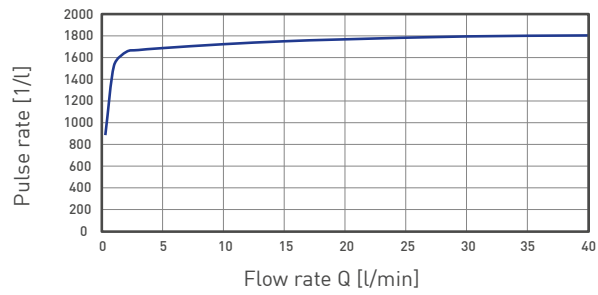

Typical pressure drop VTH / VTM / VTP / VTI

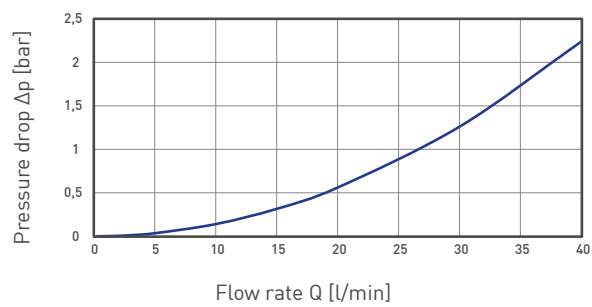

VTH15 / VT115

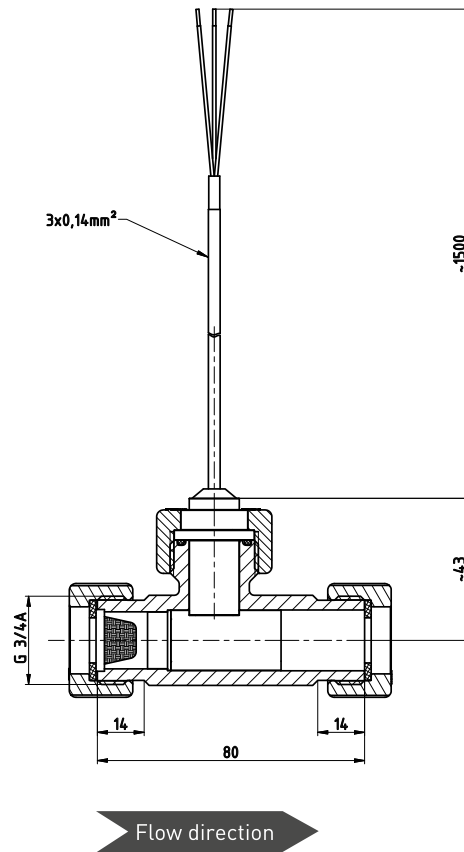

Materials in contact with fluid

	VTH15 plastic PPO	VTH15 brass	VTH15 stainless steel	VTM15 brass	VTP15 brass	VTP15 stainless steel	VTI15 plastic PPO	VTI15 brass
Pipe section	PPE+PS Noryl™ 30 % glass fibre reinforced	Brass	Stainless steel 1.4571	Brass		Stainless steel 1.4571	PPE+PS Noryl™ 30 % glass fibre reinforced	Brass
Sensor housing	PPE+PS Noryl™ 30 % glass fibre reinforced		Stainless steel 1.4571	Brass		Stainless steel 1.4571	PPE+PS Noryl™ 30 % glass fibre reinforced	
Turbine system / rotor	PEI ULTEM™			PEEK Victrex™			PEI ULTEM™	
O-ring / gasket	NBR			FKM			NBR	
Bearing system / shaft	Shaft Arcap AP1D with hard metal pins in sapphire bearings							
Bearings support	Arcap AP1D							
Rotor assembly	Hard ferrite magnet						Stainless steel pins	
Temperature sensor (optional)	Brass or stainless steel 1.4571			Brass		Brass or stainless steel 1.4571		
Screen filter	POM / Stainless steel						POM / Stainless steel	

Order code							
Type		VT1541					
VTH15 / VTI15							
Material of pipe section							
Noryl PPO		K5					
Brass		MS					
Stainless steel (only VTH15)		VA					
Version, output signal							
VT15, PNP				IP			
VT15, NPN				IN			
VTH15, NPN				HN			
Electrical connection							
Cable					P		
4 pin plug connector M12 x 1					S		
Supplementary temperature sensor							
None	None					0A4	
Pt100	3 pin plug connector M8, 3-wire	brass				BA4	
		stainless steel				CA4	
	Fixed cable, 3-wire	brass				2A4	
		stainless steel				9A4	
Pt1000	3 pin plug connector M8, 3-wire	brass				DA4	
		stainless steel				EA4	
	Fixed cable, 2-wire	brass				7A4	
		stainless steel				AA4	
Options*							
Filter							
Screen filter							H
None							0
Electronics (only for VTH15 with 4 pin plug connector M12 x 1)							
Including transducer 4...20 mA							
→ Corresponds 0...5 l/min							A
→ Corresponds 0...10 l/min							B
→ Corresponds 0...20 l/min							C
→ Corresponds 0...40 l/min							D
Switching output VE							6
Switching output VE with pulse output							7
Example order number		VT1541	K5	HN	S	CA4	H A















* If you do not require any of the options, digits of the order code do not apply.

BEST
SELLER



Type	Order number
VTH15 Material of pipe section: PPO Noryl Output signal: NPN Electrical connection: Cable, without supplementary temperature sensor Screen filter, transducer 4...20 mA corresponds 0...5 l/min	VT1541 K5 HN P 0A4

Order code		
Type		
VTM15	VT1531MSMNP	
Supplementary temperature sensor		
None		0A4
Pt100		2A4
Pt1000		7A4
Example order number	VT1531MSMNP	0A4

Order code		
Type		
VTP15	VT1541	
Material of pipe section, process connection		
Brass, G $\frac{3}{4}$ male		MSDNP0A4
Stainless steel, G $\frac{3}{4}$ male		VADNP0A4
Stainless steel, G $\frac{3}{4}$ female		VADNP0I4
Example order number	VT1541	MSDNP04A

Order code				
Series	Connection adapters*			Order number
VT15		Hose barb Ø 10 mm, PA 6.6	T _{max} = 20 °C, PN 10 T _{max} = 60 °C, PN 2.5	VT1317
		Hose barb Ø 12 mm, PP		XVT1069
		Hose barb Ø 15 mm, PP		VT1338
		Hose barb Ø 19 mm, HDPE		VT1323
		Hose barb, angleshape Ø 13 mm, HDPE	T _{max} = 60 °C, PN 10	VT1318
		Hose barb, Ø 13 mm, Brass	T _{max} = 80 °C, PN 10	XVT1005
		Bonding socket, Ø 22 mm, PVC, for pipes outer diameter 16 mm	T _{max} = 20 °C, PN 10 T _{max} = 60 °C, PN 2,5	VT1316
		Welding adapter Ø 20 mm, PP	T _{max} = 20 °C, PN 6 T _{max} = 60 °C, PN 2,5	VT1319
		Screw coupling G ³ / ₈ -ISO 228 male, Brass	T _{max} = 110 °C, PN 16	VT1320
		Screw coupling G ¹ / ₂ -ISO 228 male, Brass		VT1324
		Screw coupling G ³ / ₈ -ISO 228 female, brass galvanized		VT1321
		Screw coupling G ¹ / ₂ -ISO 228 female, Brass		VT1325
		Clamping ring coupling, brass for copper tube Ø 18 mm for copper tube Ø 22 mm		VT1326 VT1327
		Soldering coupling, brass for copper tube Ø 15 mm for copper tube Ø 18 mm		T _{max} = 90 °C, PN 16

* The use of connection adapters may result in deviations in accuracy. Supplied piecewise

Order code				
Series	Connection cables		Length	Order number
VT15		Connection cable for turbine flow sensor with cable socket M12 x 1 moulded lead, 4-pin, shielded, sheathing material PUR (T _{max} = 70 °C) UL-approval	3 m	XVT2053
			5 m	XVT2009
			10 m	XVT2070
		4 pin cable socket M12 x 1 angle type unassembled		VT1331
		Connection cable for temperature sensor with cable socket M8 moulded lead, 3 pin, sheathing material PUR (T _{max} = 90 °C) UL-approval	2 m	XVT2190
			5 m	XVT2191
			10 m	XVT2192